

9 Repeat step 7 and 8 for the other holes in the seat. Assembly order: (S = short bolt, L = long bolt.)

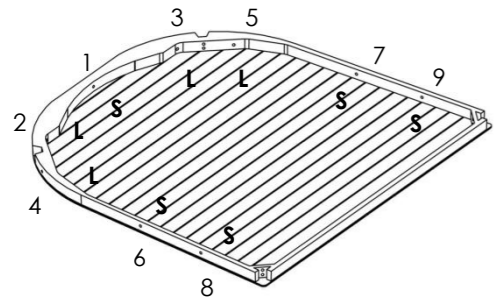

10 Tighten the bolts in the back of the seat with an allen key.

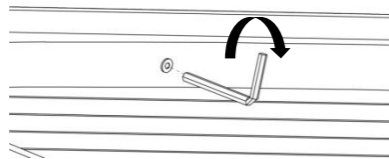

11 Repeat step 10 for the other holes in the seat. assembly order:

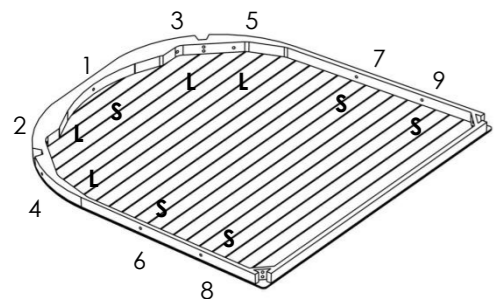

Assembly instructions
MOOD daybed

06249

Tribù nv
Langendijkstraat 5a
3690 Zutendaal
BELGIUM

www.tribu.com
info@tribu.com

TRIBÙ
The art of leisure

Content

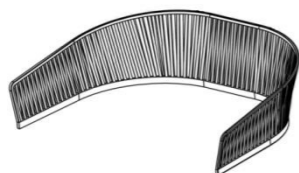

1 x part A



1 x seat

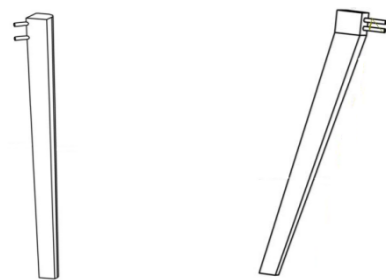

2 x front legs

2 x back legs

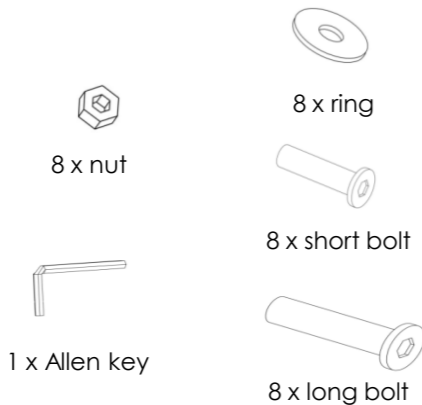

8 x nut

8 x ring

8 x short bolt

1 x Allen key

8 x long bolt

Assembly Instructions

1 Position the seat upside down on the floor.

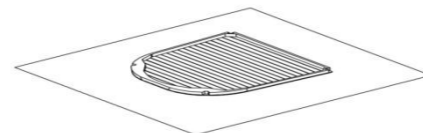

2 Assemble the front legs with 4 x nut and 4 x ring. Take 2 nuts and 2 rings. Screw nut 1 first, than nut 2.

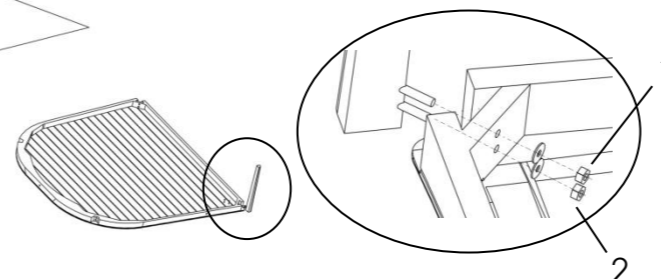

3 Repeat step 2 for the other front leg.

4 Assemble the the back legs with 4 x nut and 4 x ring. Take 2 nuts and 2 rings. Screw nut 1 first, than nut 2.

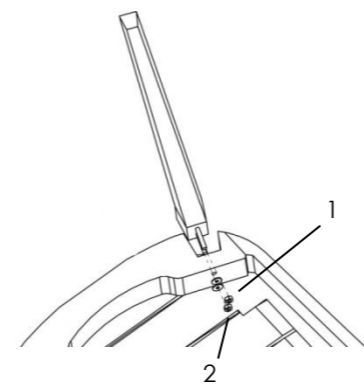

5 Repeat step 4 for the other back leg.

6 Assemble part A. Move part A on the seat.

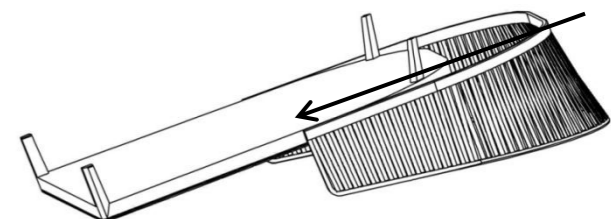

7 Search the hole in middle of the back of part A with an Allen key.

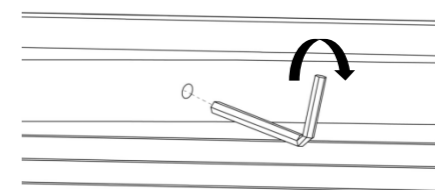

8 Take 1 short bolt. Screw the bolt in by hand. At the same time push part A against the seat.

