

Assembly instructions
Tosca Dining Tables

05355 - 05354

Tribù nv
Oude Heidestraat 72
3740 Bilzen
BELGIUM

www.tribu.com
info@tribu.com

TRIBÙ
The art of leisure

CONTENT

05354 Table



05355 Table

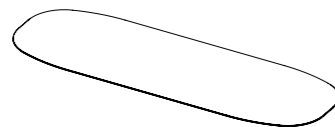

1x Table top
240 / 300 cm

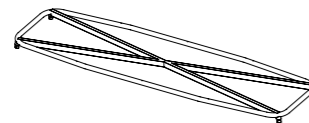
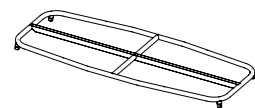

1x Frame
240 / 300 cm



4 x
Leg

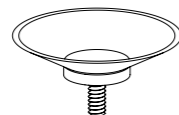

11 x
Suction Cup

ASSEMBLY INSTRUCTIONS

- 1** Open the box of the table top. Degrease the glass with tribù Glass & Ceramic Cleaner (D9938) and wipe the surface until it is dry. Leave the table top in the box.
- 2** Open the box of the frame, make sure it's upside down. Then attach the legs to the frame.

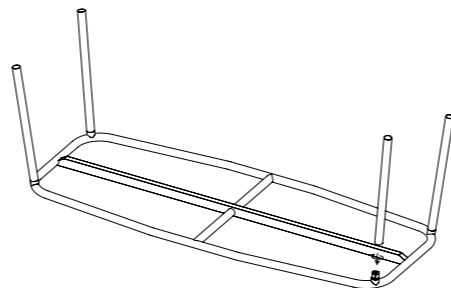

- 3** Turn the frame with the legs upside down. Fasten the suction cups onto the frame as shown in the picture below. The frame has holes in which you can fasten the threaded suction cup.

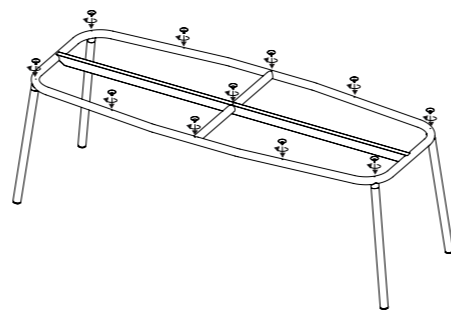

- 4** Put the table frame upside down onto the table top. The table top is marked where the suction cups should be positioned.

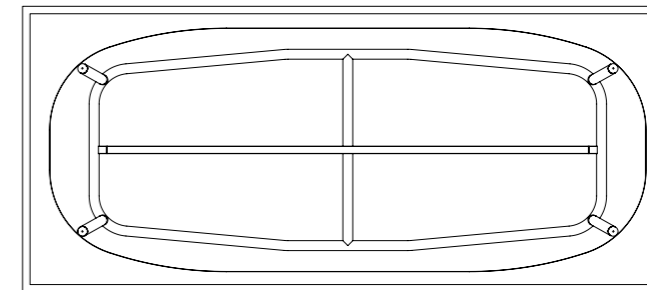

- 5** When taking the table out of the box, please hold the frame and the table top.